

DISPLAY PRESSURE SWITCH

Swiss based Trafag is a leading international supplier of high quality sensors and monitoring instruments for measurement of pressure and temperature. The DPS 8381 is the ideal combination of pressure switch and transmitter with a pressure display. The parameters are set on the device or in a timesaving way via an NFC - smartphone App. The settings in combination with a comprehensive set of options make the DPS 8381 suitable for a wide range of demanding applications.

Applications

- Machine tools
- Hydraulics
- Process technology
- Industrial applications



Features

- Parameterization also via NFC-smartphone App (Android)
- Display and electrical connection are independently rotatable 335°/343°
- Analogue output switchable mA or V
- Integrated datalogger
- Measuring range adjustable

Technical Data			
Measuring principle	Thin-film-on-steel	Accuracy @ 25°C typ.	± 0.5 % FS typ.
Measuring range	0 ... 2.5 to 0 ... 600 bar 0 ... 30 to 0 ... 7500 psi adjustable	Media temperature	-25°C ... +85°C
Output signal	4 ... 20 mA, 0 ... 5 VDC, 1 ... 6 VDC, 0 ... 10 VDC, switchable mA or V	Ambient temperature	-25°C ... +85°C
NLH @ 25°C (BSL) typ.	± 0.2 % FS typ.	Pressure unit for display	bar, psi, MPa, kPa, mWC, mmWC, inchWC, %, user scale
Switching output	2 PNP	Logger	Ring buffer: 3518 data points Sampling time: 0.1 ... 999.9 s, Off (0)

04/2023

Data sheet H72321p

Subject to change

Ordering information/type code

				8381 . XX				XX	XX	XX	XX	XX
Measuring range ¹⁾	Pressure measurement range [bar]	Over pressure [bar]	Burst pressure [bar]	Pressure measurement range [psi]	Over pressure [psi]	Burst pressure [psi]						
		0 ... 2.5	7.5	50	0 ... 30	90	700	G5				
	0 ... 4	12	60	0 ... 50	150	850	G6					
	0 ... 6	18	100	0 ... 100	300	1450	G7					
	0 ... 10	30	200	0 ... 150	450	2500	G8					
	0 ... 16	48	200	0 ... 200	600	2500	GA					
	0 ... 25	75	300	0 ... 250	750	2500	G9					
	0 ... 40	120	300	0 ... 300	900	4000	HA					
	0 ... 60	180	400	0 ... 400	1200	4000	H0					
	0 ... 100	300	500	0 ... 500	1500	4000	H1					
	0 ... 160	480	750	0 ... 1000	3000	5000	H2					
	0 ... 250	750	1000	0 ... 1500	4500	7000	H3					
	0 ... 400	1000	2000	0 ... 2000	6000	10000	H5					
	0 ... 600	1500	2500	0 ... 3000	9000	14500	G4					
				0 ... 5000	12500	21750	H4					
				0 ... 7500	18750	29000	H6					
	Option 5P: Fivefold overpressure			Option: Maximum Overpressure								
	0 ... 2.5	12.5	60	0 ... 30	150	1450	E5					
	0 ... 4	20	100	0 ... 50	180	1450	E6					
	0 ... 6	30	200	0 ... 100	450	3500	E7					
	0 ... 10	50	200	0 ... 150	700	4250	E8					
	0 ... 16	80	300	0 ... 200	700	4250	EA					
	0 ... 25	125	300	0 ... 250	1150	5750	E9					
	0 ... 40	200	400	0 ... 300	1150	5750	FA					
	0 ... 60	300	500	0 ... 400	1800	8500	F0					
	0 ... 100	500	750	0 ... 500	1800	8500	F1					
	0 ... 160	800	1000	0 ... 1000	4600	19000	F2					
Sensor	Relative pressure, accuracy class: 0.5 %; Material pressure connection and housing: 1.4542 (AISI630)						25					
	Relative pressure, accuracy class: 0.5 %; Material pressure connection and housing: 1.4404 (AISI316L) ^{2) 6) 7)}						35					
Pressure connection	G1/4" female ²⁾		10	M14x1.5 male, DIN6149-2 ²⁾			31					
	G1/4" male, Seal: DIN 3869 (accessories 61/63/83)		17	7/16"-20UNF male, DIN3866 ^{2) 4)}			18					
	G1/4" male, with integrated damping Ø 0.5 mm, Seal: DIN 3869 (accessories 61/63/83)		15	7/16"-20UNF-2A male, SAE J1926-3 (Light Duty) ^{2) 8)}			42					
	G1/4" male (Manometer) EN 837 ²⁾		53	7/16"-20UNF-2A male, SAE J1926-2 (Heavy Duty) ⁹⁾			69					
	G1/2" male (Manometer) EN 837 ²⁾		11	7/16"-20UNF female, SAE J512 with valve opener ^{2) 4)}			24					
	1/4" NPT male ²⁾		30	9/16"-18UNF-2A male, SAE J1926-3 (Light Duty), seal: accessory 61 ^{2) 8)}			61					
	1/2" NPT male ²⁾		51	9/16"-18UNF-2A male, SAE J1926-2 (Heavy Duty), seal: accessory 61 ⁹⁾			67					
	R1/4" male, DIN3858 ²⁾		19									
Electrical connection	Male electrical connector M12x1, 4-pole, Mat. PA (Accessories P3, P4)						32					
	Male electrical connector M12x1, 5-pole, Mat. PA (Accessories P1, P2)						35					
Output signal	Switching output PNP, current output 4 ... 20 mA, switchable to 0 ... 10 VDC; output detail see accessories P1, P2, P3										PA	
	Switching output PNP, voltage output 1 ... 6 VDC; output detail see accessories P1, P2, P3										PU	
	Switching output PNP, voltage output 0 ... 10 VDC; output detail see accessories P1, P2, P3										PV	
	Switching output PNP, voltage output 0 ... 5 VDC; output detail see accessories P1, P2, P3										PW	
	Switching output PNP; output detail see accessory P4										PS	

Accessories		
Pin configuration 5-pole.; 1: U+, 2: analogue, 3: U-, 4: SP1, 5: SP2		P1
Pin configuration 5-pole.; 1: U+, 2: SP2, 3: U-, 4: SP1, 5: analogue		P2
Pin configuration 4-pole.; 1: U+, 2: analogue, 3: U-, 4: SP1		P3
Pin configuration 4-pole.; 1: U+, 2: SP2, 3: U-, 4: SP1		P4
Pressure peak damping element ø 1.0 mm, material 1.4305 ⁵⁾		40
Pressure peak damping element ø 0.4 mm, material 1.4305 ⁵⁾		44
Seal FPM, -18°C ... +125°C		61
Seal EPDM, -40°C ... +125°C		63
Seal NBR, -25°C ... +100°C		83
Female electrical plug M12x1, 5-pole ³⁾		33
Parametrisation standard for output signal PS, T1 (see table "Parameters")		ZS
Parametrisation according to customer specification (see table "Parameters")		ZC
Function package 1: Zero set / Measuring range zero point adjustment		Z1
Function package 2: User scale unit / analogue output adjustment		Z2
Enhanced condensation protection		CP
Protective cap, 1 pc. F89051, package of 5 pcs. F89052, package of 25 pcs. F89075		
Adapter with flange connection, 1 pc. F82054		

¹⁾ Extended overpressure as well as customized pressure ranges upon request

²⁾ Upon request

³⁾ For electrical connections 32 and 35

⁴⁾ Max. allowable pressure range 60 bar at 120 bar overpressure

⁵⁾ Not for pressure connections 10, 11, 18, 24, 53

⁶⁾ Only with pressure connection 17 (G1/4")

⁷⁾ Only for pressure ranges ≥ 10 bar

⁸⁾ Measuring range max. 350 bar according to SAE J1926-3 (Light Duty). Do not use for new designs, will be replaced by design according to SAE J1926-2 (Heavy Duty) in 2023

⁹⁾ Measuring range max. 630 bar according to SAE J1926-2 (Heavy Duty)

Standard products (extra short lead time)

Product No.	Type Code	Pressure range [bar]	Over pressure max. [bar]	Supply [VDC]	Accuracy @ 25°C typ. [%]
DPS2.5PAP1	8381 75 2517 35 0000 0000 PA P1 44 61 ZS Z1 Z2	0 ... 2.5	7.5	15 ... 30	± 0.5
DPS4.0PAP1	8381 76 2517 35 0000 0000 PA P1 44 61 ZS Z1 Z2	0 ... 4	12	15 ... 30	± 0.5
DPS6.0PAP1	8381 77 2517 35 0000 0000 PA P1 44 61 ZS Z1 Z2	0 ... 6	18	15 ... 30	± 0.5
DPS10.0PAP1	8381 78 2517 35 0000 0000 PA P1 44 61 ZS Z1 Z2	0 ... 10	30	15 ... 30	± 0.5
DPS16.0PAP1	8381 79 2517 35 0000 0000 PA P1 44 61 ZS Z1 Z2	0 ... 16	48	15 ... 30	± 0.5
DPS25.0PAP1	8381 80 2517 35 0000 0000 PA P1 44 61 ZS Z1 Z2	0 ... 25	75	15 ... 30	± 0.5
DPS40.0PAP1	8381 81 2517 35 0000 0000 PA P1 44 61 ZS Z1 Z2	0 ... 40	120	15 ... 30	± 0.5
DPS60.0PAP1	8381 82 2517 35 0000 0000 PA P1 44 61 ZS Z1 Z2	0 ... 60	180	15 ... 30	± 0.5
DPS100.0PAP1	8381 83 2517 35 0000 0000 PA P1 44 61 ZS Z1 Z2	0 ... 100	300	15 ... 30	± 0.5
DPS160.0PAP1	8381 85 2517 35 0000 0000 PA P1 44 61 ZS Z1 Z2	0 ... 160	480	15 ... 30	± 0.5
DPS250.0PAP1	8381 74 2517 35 0000 0000 PA P1 44 61 ZS Z1 Z2	0 ... 250	750	15 ... 30	± 0.5
DPS400.0PAP1	8381 84 2517 35 0000 0000 PA P1 44 61 ZS Z1 Z2	0 ... 400	1000	15 ... 30	± 0.5
DPS600.0PAP1	8381 86 2517 35 0000 0000 PA P1 44 61 ZS Z1 Z2	0 ... 600	1500	15 ... 30	± 0.5

Parameters				
Name	Standard setting (accessory ZS)	Value range	Short name	Customer adjustment (accessory ZC)
Switch point SP1 (hysteresis mode) Upper switch point FH1 (window mode)	75 % Measuring range	SP1 > RP1 FH1 > FL1 Hysteresis ≥ 1 % FS	SP1	
Reset point RP1 (hysteresis mode) Lower switch point FL1 (window mode)	25 % Measuring range	RP1 < SP1 FL1 < FH1 Hysteresis ≥ 1 % FS	RP1	
Switch point SP2 (hysteresis mode) Upper switch point FH2 (window mode)	75 % Measuring range	SP2 > RP2 FH2 > FL2 Hysteresis ≥ 1 % FS	SP2	
Reset point RP2 (hysteresis mode) Lower switch point FL2 (window mode)	25 % Measuring range	RP2 < SP2 FL2 < FH2 Hysteresis ≥ 1 % FS	RP2	
Switch point delay time SP1 (hysteresis mode) Switch point delay time FH1 (window mode)	0	0 ... 99.99 s	dS1	
Switch point delay time RP1 (hysteresis mode) Switch point delay time FL1 (window mode)	0	0 ... 99.99 s	dR1	
Switch point delay time SP2 (hysteresis mode) Switch point delay time FH2 (window mode)	0	0 ... 99.99 s	dS2	
Switch point delay time RP2 (hysteresis mode) Switch point delay time FL2 (window mode)	0	0 ... 99.99 s	dR2	
Functions switching output 1	Hysteresis, closer (Hno)	Hysteresis NO (Hno), Hysteresis NC (Hnc) Window NO (Fno), Window NC (Fnc)	ou1	
Functions switching output 2	Hysteresis, closer (Hno)	Hysteresis NO (Hno), Hysteresis NC (Hnc) Window NO (Fno), Window NC (Fnc)	ou2	
Pressure units	bar	bar, psi, MPa, kPa, mWC, inchWC	uni	
Measuring range adjustment	100 % Nominal pressure	50 ... 100 % Nominal	P_EP	
Damping (analogue output)	0.01 s	0.01 ... 3.00 s (time constant)	dAA	
Display rotation	No	no, yes (180°)	disr	
Display mode	Current pressure value	Pressure value: current, highest, lowest, display off Current value: decimal places selectable (max. 3)	dis	
Display actualisation	2	1, 2, 5, 20 Hz	duPd	

Specifications		
Electrical data	Output / supply voltage	4 ... 20 mA: 24 (15 ... 30) VDC 0 ... 5 VDC: 24 (15 ... 30) VDC 1 ... 6 VDC: 24 (15 ... 30) VDC 0 ... 10 VDC: 24 (15 ... 30) VDC
	Power-on delay time	Typ. 200 ms
	Inverse-polarity protection, short-circuit strength @ 25°C during 5 min.	integrated
	Current consumption / power consumption	≤ 30 mA
Environmental conditions	Media temperature	-25°C ... +85°C
	Ambient temperature	-25°C ... +85°C
	Protection ¹⁾	IP67
	Humidity	Max. 95 % relative
	Vibration	10 g (10 ... 2000 Hz)
	Shock	50 g / 3 ms
EMC protection	Emission	EN/IEC 61000-6-3
	Immunity	EN/IEC 61000-6-2
Mechanical data	Sensor (wetted parts)	1.4542 (AISI630)
	Pressure connection (wetted parts)	1.4542 (AISI630) or 1.4404 (AISI316L) ²⁾
	Housing	Zinc based die-casting alloy nickel plated display housing plastic
	Sealing	FPM, NBR, EPDM
	Male electrical connector	See ordering information
	Weight	~ 189 g
	Mounting torque	15 ... 20 Nm
	Housing alignment	Display 335° rotatable, max. 2.5 Nm Electrical connection 343° rotatable, max. 5 Nm

¹⁾ See electrical connection

²⁾ See ordering information for sensor

Measuring accuracy 0.5 %

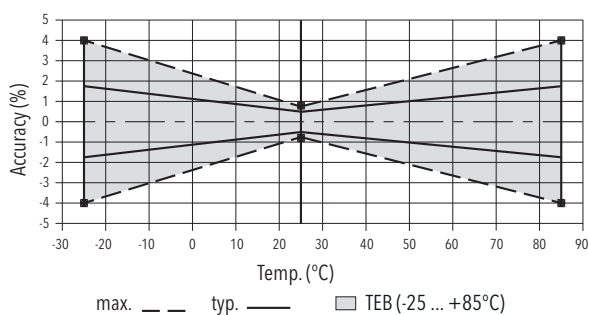

Analogue output			
Output signal	Switchable 4 ... 20 mA or voltage		
Accuracy	TEB @ -25 ... +85°C	[% FS typ.]	± 1.75
	Accuracy @ +25°C	[% FS typ.]	± 0.5
	NLH @ +25°C (BSL)	[% FS typ.]	± 0.2
	TC zero point and span	[% FS/K typ.]	± 0.03
	Long term stability 1 year @ +25°C	[% FS typ.]	± 0.1
Current limiting output signal	4 ... 20 mA: 25 mA (overload)		
	0 ... 10 VDC: < 40 mA (short-circuit)		
Damping (rise time)	0.01 ... 3.00 s / 10 ... 90 % Nominal pressure		
Zero set; ¹⁾	± 0.2 % FS		
Offset correction of analogue output and display indication			
Measuring range zero point adjustment (P_nP) ¹⁾	0 ... 50 % FS ²⁾		
Measuring range end point adjustment (P_EP)	50 ... 100 % FS ²⁾		
Zero point adjustment analogue output (o_nP) ¹⁾	Voltage output: 0 ... 2 VDC		
	Current output: 3.9 ... o_EP - 8 mA		
End point adjustment analogue output (o_EP) ¹⁾	Voltage output: o_nP + 4 ... 10.5 VDC		
	Current output: o_nP + 8 ... 20.1 mA		

¹⁾ Available with optional function package, see "Accessories"

²⁾ P_EP - P_nP ≥ 50 % FS

Switching output			
Accuracy	Accuracy @ +25°C	[% FS typ.]	± 0.5
	TEB @ -25 ... +85°C	[% FS typ.]	± 1.0
	Long term stability 1 year @ +25°C	[% FS typ.]	≤ ± 0.3
Setting range of switchpoints	0 ... 100 % FS		
Switching hysteresis	≥ 1 % FS		
	Switchpoint > reset point		
Switching resistance	≤ 3 Ω		
Output function	Hysteresis, Window; normally closed (NO), normally open (NC)		
Switching current	≤ 0.5 A each switching output		
Current limiting	≤ 2 A each switching output		
Life time	> 100 x 10 ⁶ cycles		
Switching frequency	max. 200 Hz		
Delay time	0 ... 99.99 s		

Display	
Display	4-digit 7-segment display 180° flippable with disable function Standard decimal places: ≤ 9: 3 decimal places 10 ... 99: 2 decimal places 100 ... 999: 1 decimal place
Switching status indication	2 LED, red
Operation	With 3 buttons and menu navigation according to VDMA 24574-1
Display resolution	0.1 % FS
Display range	-3 ... 103 % FS
Setting parameters	See table Parameters
User scale unit;	Display zero point: -999 ... 9998
User defined values for display indication zero point and end point ¹⁾	Display end point: -998 ... 9999

¹⁾ Available with optional function package, see "Accessories"

Dimensions

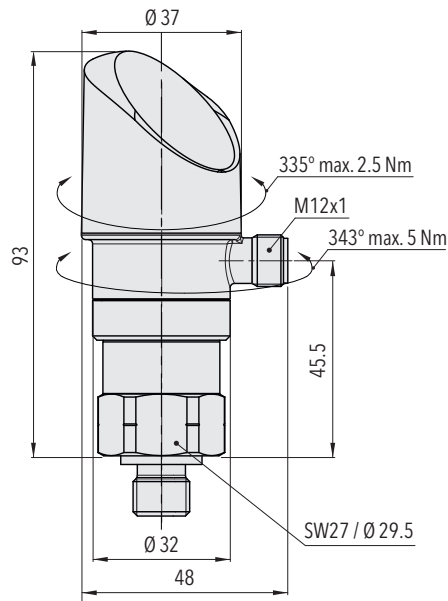

8381.XX.XXXX.35/32.XX.XX

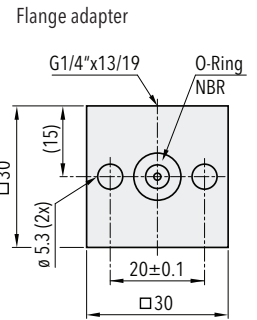
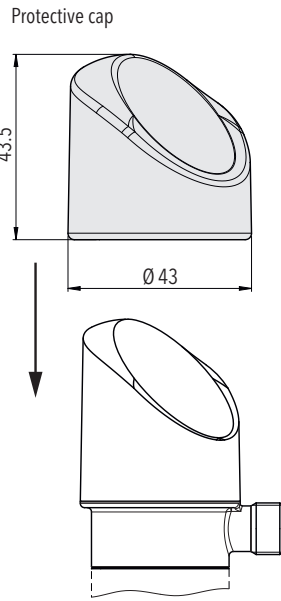

F82054
Mounting accessory included

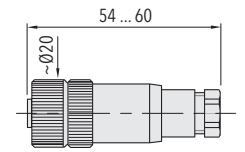

8381.XX.XXXX.XX.XX.33

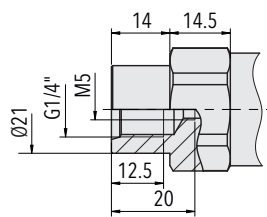

8381.XX.XX10.XX.XX.XX

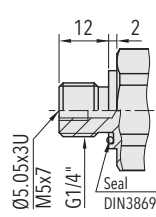

8381.XX.XX17.XX.XX.XX

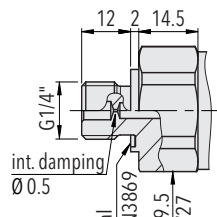

8381.XX.XX15.XX.XX.XX

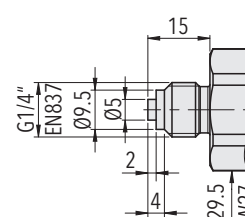

8381.XX.XX53.XX.XX.XX

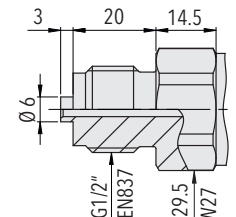

8381.XX.XX11.XX.XX.XX

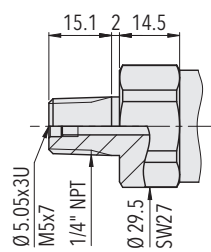

8381.XX.XX30.XX.XX.XX

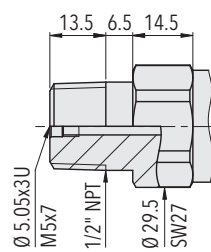

8381.XX.XX51.XX.XX.XX

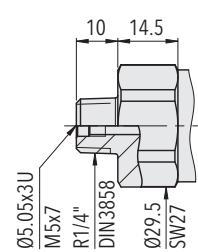

8381.XX.XX19.XX.XX.XX

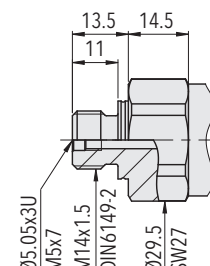

8381.XX.XX31.XX.XX.XX

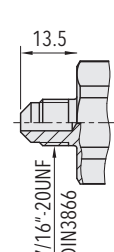

8381.XX.XX18.XX.XX.XX

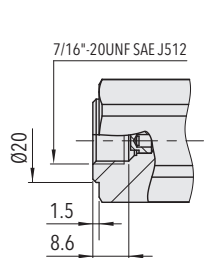

8381.XX.XX24.XX.XX.XX

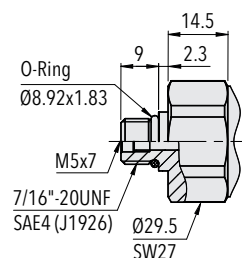

8381.XX.XX42.XX.XX.XX

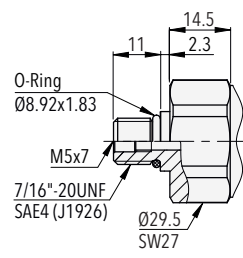

8381.XX.XX69.XX.XX.XX

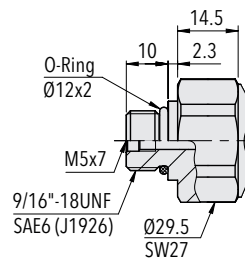

8381.XX.XX61.XX.XX.XX

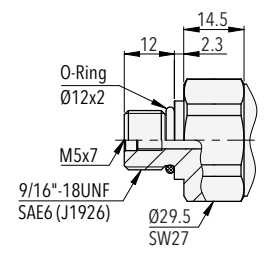

8381.XX.XX67.XX.XX.XX

Electrical connection

		Protection / electrical connection			
		IP67*)			
		M12x1			
		5-pole 35		4-pole 32	
Output signal		P1	P2	P3	P4
	PA	✓	✓	✓	
	PU	✓	✓	✓	
	PV	✓	✓	✓	
	PW	✓	✓	✓	
	PS				✓
Pin Configuration		P1	P2	P3	P4
	U _S + U _S - Out analogue SP1 SP2 Shield *** 8381..XX.XXXX.XX.PA/PU/PV/PW/PS	1 3 2 4 5 Shield ***	1 3 5 4 2 Shield ***	1 3 2 4 Shield ***	1 3 - 4 2 Shield ***

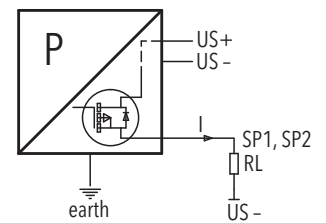

Connection of loads to switching output

*) Provided female connector is mounted according to instructions

***) The use of a shielded cable is recommended

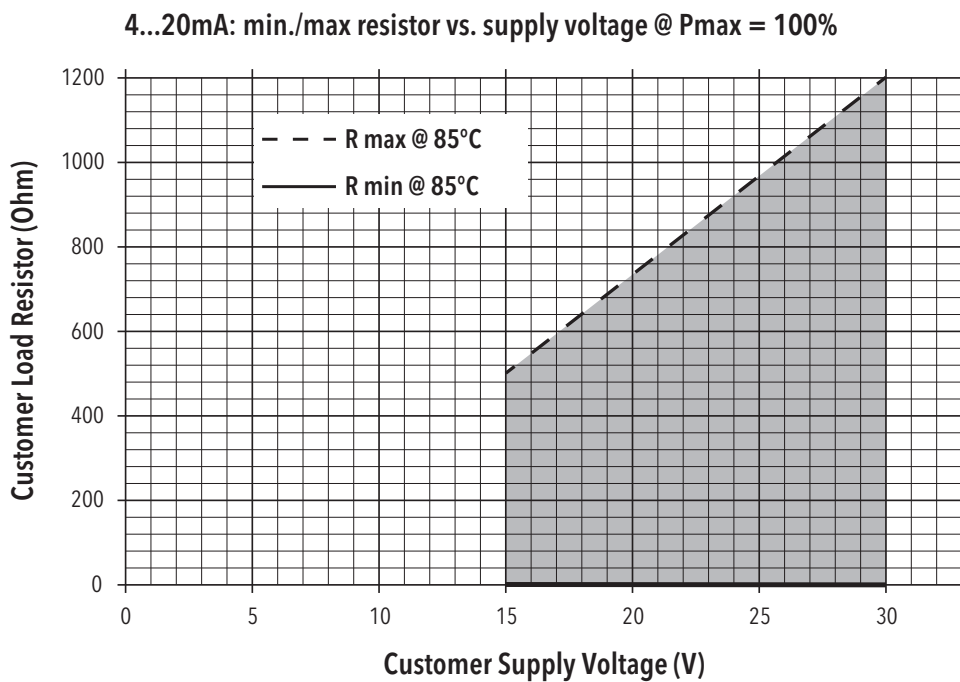

Functions switching output

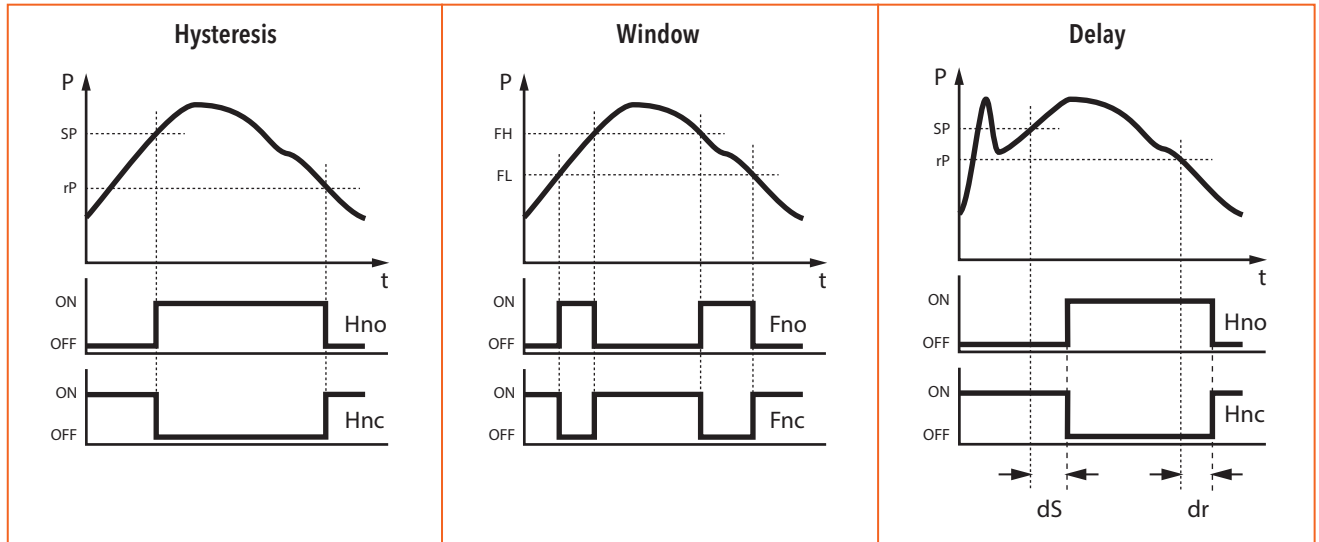

Additional information

Documents

Data sheet	www.trafag.com/H72321
Instructions	www.trafag.com/H73320
Flyer	www.trafag.com/H70694